



THARO V-Series Users Manual



FCC COMPLIANCE STATEMENT FOR AMERICAN USERS

This equipment has been tested and found to comply with the limits for a CLASS A digital device, pursuant to Part 15 of the FCC Rules. These limits are designed to provide reasonable protection against harmful interference when the equipment is operated in a commercial environment. This equipment generates, uses, and can radiate radio frequency energy and, if not installed and used in accordance with the instructions, may cause harmful interference to radio communications. Operation of this equipment in a residential area is likely to cause harmful interference in which case the user will be required to correct the interference at his expense.

EMS AND EMI COMPLIANCE STATEMENT FOR EUROPEAN USERS

This equipment has been tested and passed with the requirements relating to electromagnetic compatibility based on the standards EN50081-1 (EN55022 CLASS A) and EN61000-4-2/-3/-4/-5/-6/-8/-11 (IEC Teil 2,3,4). The equipment also tested and passed in accordance with the European Standard EN55022 for both the Radiated and Conducted emissions limits.

CAUTION

Danger of explosion if battery is replaced incorrectly.

Only replace battery with an equivalent type as recommended by the manufacturer.

Dispose of used batteries according to the manufacturer's instructions.

Copyright and Trademark Notice

© 2004 by Tharo Systems, Inc.

It is illegal to photocopy or electronically transmit a facsimile of this manual or any portion of its contents for any means or purpose without the publisher's permission. Fines of up to \$10,000.00 may be imposed for violation.

All brand or product names are trademarks or registered trademarks of their respective companies.

TABLE OF CONTENTS

1. PRODUCT DESCRIPTION.....	5
General Information.....	5
Printer Options.....	5
2. GENERAL SAFETY TIPS	7
3. UNPACKING THE PRINTER AND ACCESSORIES.....	7
4. IDENTIFYING COMPONENTS	8
5. PRINTER SETUP.....	9
6. CONTROL PANEL.....	10
General Description and Operation	10
Interpreting LED Messages.....	10
7. LOADING MEDIA	11
Ribbon Installation	11
Label Installation	12
Label Roll Core Installation Instructions	13
Direct Thermal / Thermal Transfer Mode Switch.....	14
Card / Hang tag installation	14
8. INSTALLING THE PRINTER'S OPTIONAL ACCESSORIES	15
THARO V-Series Stripper Sensor Module Components	15
THARO V-Series Stripper Sensor Module Installation Instructions	15
Stripper Sensor Module Installation Diagram	17
THARO V-Series Cutter Module Components.....	18
THARO V-Series Cutter Module Installation Instructions	18
THARO V-Series 2MB Flash Memory Expansion with Real-Time Clock Components	20
THARO V-Series 2MB Flash Memory Expansion with Real-Time Clock Installation Instructions.....	20
APPENDIX A. COMMUNICATION INTERFACES	22
Parallel Interface.....	22
Serial Interface.....	22

USB Interface.....	23
Installation of the USB HS Serial Converter.....	23
Removing the USB HS Serial Converter.....	25
APPENDIX B. ERROR MESSAGES / TROUBLESHOOTING	26
Self Test	26
Dump Mode.....	26
LED Error Message Descriptions.....	27
Problems and Recommended Solutions	28
APPENDIX C. MAINTENANCE AND ADJUSTMENT	29
Cleaning the Thermal Printhead	29
Thermal Printhead Print Line Adjustment.....	30
Thermal Printhead Spring Box Pressure Adjustment	30
Thermal Printhead Replacement	31
Auto Sensing	32
Upgrading the Printer's Firmware	32
Printer Setup	32
Clearing Cutter Jams.....	33
Cleaning Adhesive from the Cutter Blade.....	33

Warranty Information

The THARO V-426/V-433 printers are warranted against defects in material or workmanship for 12 months (365 days) from the date of original shipment by THARO SYSTEMS, INCORPORATED. This warranty does not cover normal wear and tear and shall be null and void if the equipment is modified, improperly installed or used, damaged by accident or neglect, or in the event any parts are improperly installed or replaced by the user.

Since printhead wear is part of normal operations, a printhead warranty of 3 months (90 days) from the date of original shipment by THARO SYSTEMS, or 2,000,000 linear inches of use, whichever comes first. To qualify for this warranty, the printhead must be returned to THARO or another authorized service center. Although the user is not required to purchase THARO brand supplies (media and/or ribbons), to the extent it is determined that the use of other supplies (media and/or ribbons) shall have caused any defect in the thermal printhead for which a warranty claim is made, the user shall be responsible for THARO's customary charges for labor and materials to repair such defect. To the extent that it is determined that failure to follow the preventive maintenance schedule and procedures listed in the User Guide shall have caused any defect in the thermal printhead for which a warranty claim is made, this limited warranty shall be void. Any printhead returned to THARO with scratches or abrasions on the printhead at the point of failure will be deemed abused and no warranty replacement will be provided.

THARO SYSTEMS' SOLE OBLIGATION UNDER THIS WARRANTY SHALL BE TO FURNISH PARTS AND LABOR FOR THE REPAIR OR REPLACEMENT OF PRODUCTS FOUND TO BE DEFECTIVE IN MATERIAL OR WORKMANSHIP DURING THE WARRANTY PERIOD.

As a condition of this warranty, the user must: (a) obtain a THARO Return Authorization for the printer, or subassembly(s); (b) ship the printer or subassembly(s), transportation prepaid to the authorized service location; and (c) include with the Product or subassembly(s) a written description of the claimed defect. Unless THARO SYSTEMS authorizes return of the entire Product, the user shall return only the subassembly(s). Products returned shall be packaged in the original packing and shipping container or comparable container. In the event equipment is not so packaged or if shipping damage is evident, it will not be accepted for service under warranty. Surface transportation charges for the return of the printer to the customer shall be paid by THARO SYSTEMS within the 48 contiguous states and the District of Columbia. Customer shall pay shipping costs, customs clearance, and other related charges outside the designated area. If THARO SYSTEMS determines that the Product returned to it for warranty service or replacement is not defective as herein defined, BUYER shall be subject to a minimal labor charge and all costs of handling and transportation.

Warranty Exclusions and Conditions

The above warranties are in lieu of all other warranties, expressed or implied, oral or written, statutory or otherwise, including any **implied warranty of merchant-ability or fitness for a particular purpose**.

THARO SYSTEMS shall not be responsible for the specific application to which any Products are applied, including but not limited to compatibility with other equipment.

All statements, technical information and recommendations relating to THARO Products are based upon tests believed to be reliable but do not constitute a guarantee or warranty.

THARO SYSTEMS SHALL NOT, UNDER ANY CIRCUMSTANCES WHATSOEVER, BE LIABLE TO BUYER OR ANY OTHER PARTY FOR LOST PROFITS, DIMINUTION OF GOODWILL OR ANY OTHER SPECIAL OR CONSEQUENTIAL DAMAGES WHATSOEVER WITH RESPECT TO ANY CLAIM HEREUNDER. IN ADDITION, THARO SYSTEMS' LIABILITY FOR WARRANTY CLAIMS SHALL NOT, IN ANY EVENT, EXCEED THE INVOICE PRICE OF THE PRODUCT CLAIMED DEFECTIVE, NOR SHALL THARO SYSTEMS BE LIABLE FOR DELAYS IN REPLACEMENT OR REPAIR OF PRODUCTS

No salesperson, representative or agent of THARO SYSTEMS is authorized to make any guarantee, warranty, or representation in addition to the foregoing warranty.

NO WAIVER, ALTERATION, ADDITION, OR MODIFICATION OF THE FOREGOING WARRANTIES SHALL BE VALID UNLESS MADE IN WRITING AND SIGNED BY AN EXECUTIVE OFFICER OF THARO SYSTEMS.

1. Product Description

General Information

The THARO V-426 and V-433 Printers are Thermal Transfer/Direct Thermal label Printers designed for use on a desktop. The compact V-426 and V-433 feature a small footprint to fit your work environment. The V-Series Printers are constructed of a durable, impact-resistant composite with a media window for easy viewing and monitoring of remaining supplies.

The THARO V-426 features a printhead density of 8 dots/mm (203 dots/in) and a maximum print length of 1727mm (68"). The THARO V-433 features a printhead density of 12 dots/mm (300 dots/in) and a maximum print length of 762mm (30").

The THARO V-426 and V-433 Printers provide 5" diameter label roll and 300 meter length ribbon capacities giving you the benefit of less downtime and increased production. Both Printers come standard with built-in USB for high-speed data transfer from your PC.

Accessories available for the THARO V-426 and V-433 Printers include a Cutter for ticket or receipt printing applications, an internal Ethernet Card for network connectivity, a 2MB Flash expansion module with a Real-Time Clock for time and date stamping of labels and a Stripper Sensor Module so the Printers can be used in strip-and-peel applications.

Printer Options

Stripper Sensor Module

The Stripper Sensor Module is used to sense printed labels in strip-and-peel applications. With the Stripper Sensor Module installed, the printed labels are presented for removal and the used liner feeds from the printer and pools on the floor.

Cutter

The optional Cutter can be used to cut labels or tag stock up to a 10-mil (.254mm) thickness. Cutter options include a choice of: cut after each label, cut after a specific quantity of labels, or cut at the end of a print job.

2MB FLASH memory module with Real-Time Clock

The Printer has the ability to use internal Flash memory for storing downloaded files including graphics and fonts. This option provides an additional 2MB of memory above and beyond the 1MB that is standard in the Printer. This increases the available space for the storage of these files. This module also includes a Real-Time Clock for the Time and Date stamping of your labels.

Internal Ethernet Adapter Card

The Internal Ethernet Adapter Card provides networking capability to the V-426 and V-433.

External Label Stand

The External Label Stand allows the use of label rolls with an outside diameter of 203.2 (8").

EASYLABEL® - Label Design Software for Windows

EASYLABEL® labeling software allows you to drive your Printer and create a full range of label formats with a minimum of effort. EASYLABEL can be installed under Microsoft Windows® on IBM PCs and compatibles. For further information about EASYLABEL, please contact your THARO Reseller.

Technical Specifications - Specifications are subject to change without notice.

Model	THARO V-426	THARO V-433
Resolution	8 dots/mm (203dpi)	12 dots/mm (300dpi)
Print Mode	Thermal Transfer/Direct Thermal	Thermal Transfer/Direct Thermal
Printer CPU	16 Bit Processor	
Sensor Location	Moveable, center aligned	
Sensor Type	Reflective, Transmissive	
Sensor Detection	Type: Label gap and black mark sensing Detection: Label length auto sensing and/or program command setting	
Print Speed	50.8mm (2")/sec ~ 152.4mm (6")/sec	50.8mm (2")/sec ~ 76.2mm (3")/sec
Print Length	12mm (0.47") ~ 1727mm (68")	12mm (0.47") ~ 762mm (30")
Print Width	25mm (1") ~ 104mm (4.09")	25mm (1") ~ 104mm (4.09")
Media	Label Roll: Max. 127mm (5") O.D. on 25mm (1") core Core Diameter: 25mm (1") ~ 76.2mm (3") Width: 25.0mm (1") ~ 118.0mm (4.65") Thickness: 0.06mm (0.002") ~ 0.25mm (0.009") Optional: External Label Stand allows use of 203.2mm (8") O.D. Label Rolls	
Ribbon	Material: Thermal Transfer ribbons (wax, resin and wax/resin) Type: Ink outside Length: 300m (981') Width: 30mm (1.18") ~ 110mm (4.33") Inner Core Diameter: 25.4mm (1") Ribbon Roll Diameter: 64mm (2.52")	
Printer Language	TPL (Tharo Programming Language)	
Software	Application: EASYP LABEL ® Start Driver: Microsoft Windows 95, 98, ME, NT 4, 2000 and XP	
Resident Fonts	9 resident alphanumeric fonts (including OCR A & B) that are available in 4 orientations (0°, 90°, 180°, 270°), 8-point sizes (6, 8, 10, 12, 14, 18, 24, 30), and are expandable 8 times horizontally and vertically.	
Downloadable Fonts	Windows Bit-map fonts and Asian fonts are downloadable. Windows fonts in 4 orientations (0°, 90°, 180°, 270°). Asian fonts in 8 orientations.	
Image Handling	BMP and PCX	
Bar Codes	Code 39, Code 93, Code 128 (subset A, B, C), UCC 128, UPC A, UPC E, UPC 2 & 5 digit add on, I 2 of 5, EAN 8, EAN 13, EAN 2 & 5 digit add on, Codabar, Postnet, EAN 128, DUN 14, MaxiCode, PDF417, and DataMatrix	
Interfaces	Serial, Parallel, USB	
Serial Interface Transmission Speed	Baud rate 4800 ~ 115200, XON/XOFF, DSR/DTR	
Memory	Built-In: 1MB Flash, 2MB DRAM Optional: An additional 2MB of Flash	
Display	Two bi-color LED lamps: Status and Ready One Control key: Feed	
Power	Auto Switching 110/240VAC, 50/60 Hz	
Real-Time Clock	Optional Time and Date stamp	
Environment	Operation: 5°C to 40°C (40°F to 104°F) Storage: -20°C to 50°C (-40°F to 122°F)	
Humidity	Operation: 30-85%, non-condensing. Free air. Storage: 10-90%, non-condensing. Free air.	
Agency Listings	CE, CUL, FCC Class A	
Printer Dimensions	Length: 285mm (13.78") Height: 171mm (6.7") Width: 226mm (8.9") Weight: 2.8Kg (6.2lbs)	
Options	Cutter Module Stripper Sensor Module 2MB Flash expansion + Real-Time Clock Internal Ethernet Adapter Card External Label Stand	

2. General Safety Tips



CAUTION!

- During the print process the printhead will become hot. Do NOT attempt to clean the printhead until it has had time to cool.
- The Printhead is the Most Fragile part of your Printer. Do NOT use sharp or hard objects to clean the Printhead. Do NOT touch the glass surface of the Printhead with your hand.
- This Printer is built exclusively to print labels, tickets and tags, continuous paper, etc. Only use media that is recommended for a direct thermal or thermal transfer Printer.
- The Printer is configured for input voltages of 110 to 240 V. Connect only to a power outlet with a grounded contact. Always ensure the Printer is switched OFF before connecting the power cord to an electrical outlet.
- Do not expose the Printer to moisture or operate it in wet or damp areas.
- Remove the power cord from the rear of the Printer when disconnecting or attaching accessories such as Stripper Sensors, Cutters, etc.

3. Unpacking the Printer and Accessories

Check the condition of the packaging and contents for possible damage during transit.



NOTICE: Please retain original boxes and all original packing materials in case the Printer must be returned.

In addition to this manual the following items should be included with your Printer:

- Bar Code Printer
- Power Cord (110V or 230V)
- Switching Power Adapter
- Ribbon Shaft, Qty. 2
- Label Roll Core
- Empty Ribbon Roll
- Quick Start Guide
- Accessories CD: Includes Label Software, Manuals and Windows Drivers

The following additional items are necessary for generating labels from your Printer:

- Serial, Parallel, or USB cable
- Applicable media (label stock/ribbon)

4. Identifying Components

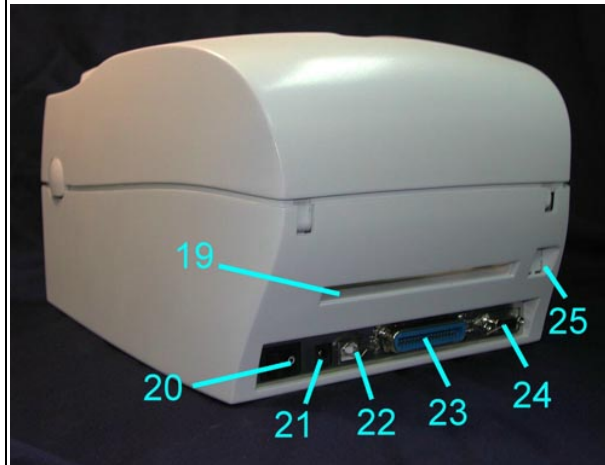
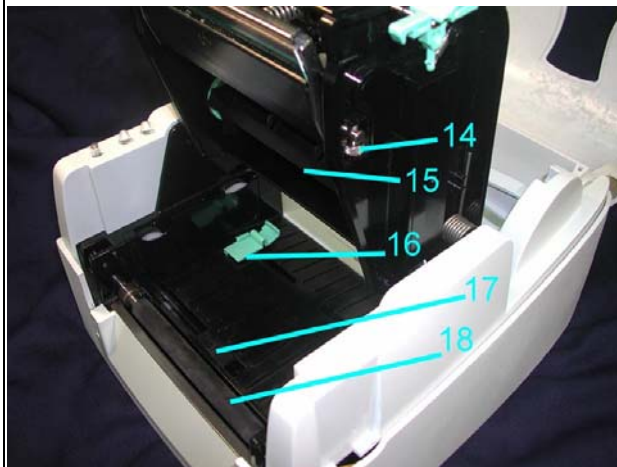
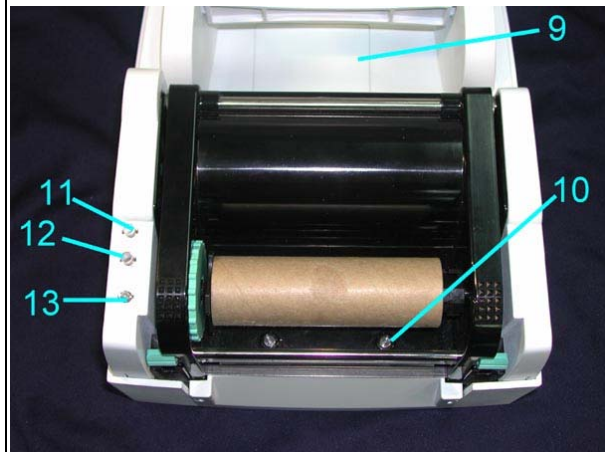
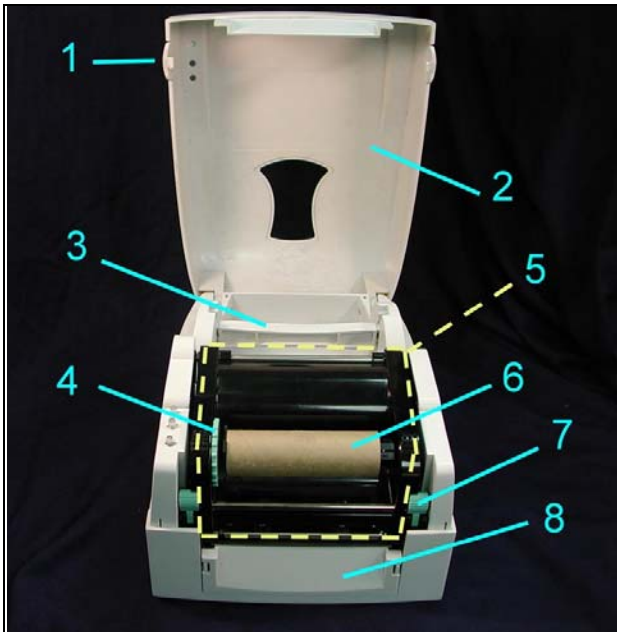

1	Open Cover Button	10	Printhead Pressure Adj. Screw (left/right)	19	Fan-Fold Label Slot
2	Top Cover	11	LED (Ready)	20	Power Switch
3	Label Roll Core	12	LED (Status)	21	Power Socket
4	Ribbon Rewind Wheel	13	FEED Key	22	USB Port
5	Print Mechanism	14	Print Line Adjustment	23	Parallel Port
6	Ribbon Rewind Shaft + Empty Ribbon Take Up Core	15	Ribbon Supply Shaft	24	Serial Port
7	Head Latches (left/right)	16	Label Guide		
8	Front Cover Panel	17	Label Sensor	25	Ethernet Socket (Optional)
9	Memory Expansion Cover	18	Platen Roller		

5. Printer Setup



CAUTION!

When choosing a location for the Printer, ensure that the Printer and operator remain dry. If the Printer or the operator get wet, serious injury to the operator or damage to the Printer may occur.



CAUTION!

Make sure that the Printer's power switch is in the "O" or "Off" position before proceeding with the installation.

1. Plug the lead from the Switching Power Adapter into the Printer's power socket.
2. Plug the supplied power cord into the Switching Power Adapter and then plug the other end of the power cord into a grounded outlet.
3. Select the correct cable for the chosen interface. The Printer can be directly connected to the PC in one of 3 ways: USB, parallel, or serial. For the connection to the USB port use a suitable USB cable. For the connection to the PC's parallel port use a suitable parallel interface cable. If the serial interface is used make sure the proper serial cable is used. You can find pin assignments and descriptions for all three interfaces connectors in Appendix A.



NOTICE!

For Serial communications make sure that the Serial Port Settings in the Printer are configured the same as in the software you will be using with the Printer.



NOTICE!

If you wish to connect the Printer to the computer using the USB interface, you must install the "USB HS Serial Converter". (See 'Appendix A. Communication Interfaces' for more details.)

4. Connect the Printer to the computer with the selected cable. Then secure the cable using any screws or clips attached to the connectors. These prevent the connection from working loose.
5. Turn the Printer on, the Ready LED will glow green when the Printer is on.

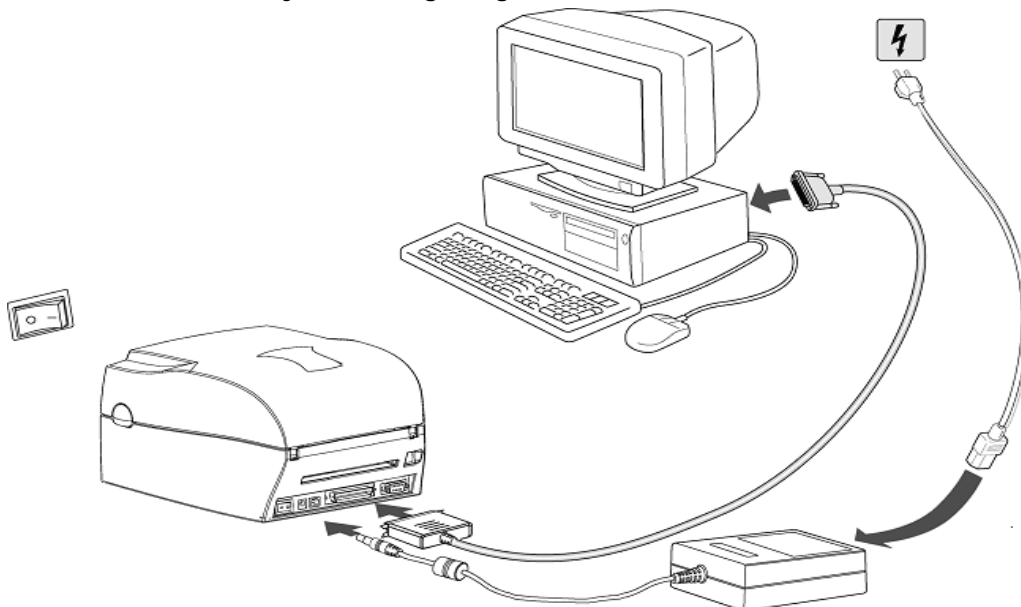

6. Control Panel

General Description and Operation

Feed Key

Pressing the Feed key will cause the Printer to advance the media (according to media type) to a specified stop position. If the Printer is loaded with continuous media the Printer will feed the media out a certain length. If the Printer is loaded with labels with gaps or black marks, the Printer will advance one label at a time. If the label is not sent out in a correct position the sensor must be calibrated. Follow the instructions for Sensor Calibration in the Maintenance and Adjustment section of this manual.

Interpreting LED Messages

	LED		Beep	Description
	Ready	Status		
	Green		1	Normal
	Red	Orange	3	The Printer is printing a Self-Test Label. Refer to Appendix B for more information.
	Green	Orange	3	The Printer is in Dump Mode. Refer to Appendix B for more information.
	Orange	Orange	3	Printer is in Auto-Sensing Mode. Please refer to Appendix C for more information.
		Red (Flash)		The Printer is in firmware download mode.

7. Loading Media

Ribbon Installation

1. Open the Printer's top cover.



2. Release the Print Mechanism by pushing in on the Head Latches. The Print Mechanism will now rotate up.

3. Remove the Ribbon Supply and Ribbon Rewind Shafts.

4. Place the new Ribbon Roll onto the Ribbon Supply Shaft and reinstall the Shaft in the printer.



5. Feed the ribbon from the Ribbon Supply Shaft under the Printhead.

6. Place the empty ribbon core onto the Ribbon Rewind Shaft and reinstall the Shaft in the printer.



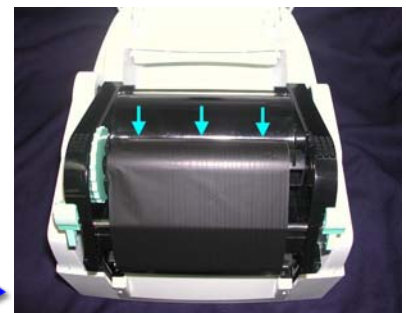
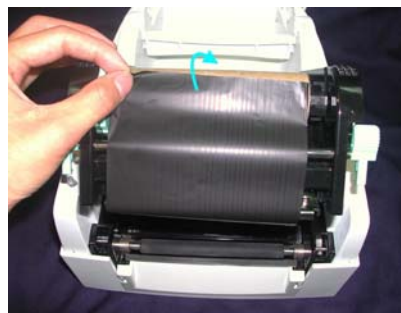

7. Secure the ribbon to the empty ribbon roll core with tape or part of a label and wrap the ribbon around the core.

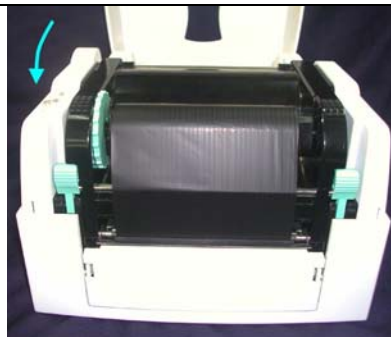

8. Close the Print Mechanism by firmly pressing down on it. You will hear a click when the Print Mechanism has been secured.

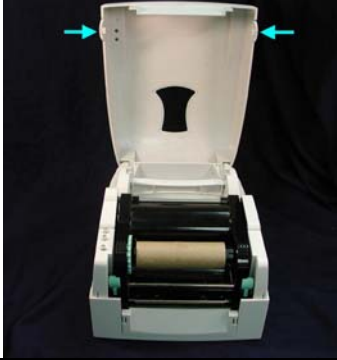

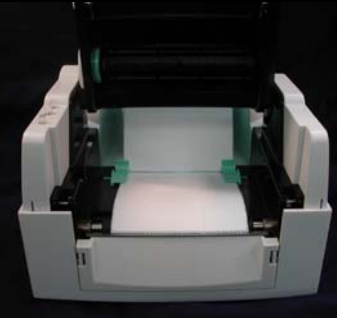
Label Installation

<p>1. Open the Printer's top cover.</p>		 A top-down view of a white printer with its top cover open. Two blue arrows point outwards from the top edge of the cover, indicating it is open.	
<p>2. Place the roll of label stock onto the Label Roll Core and place it in the printer.</p>		 A top-down view of the printer with the label roll core installed inside. The roll of label stock is partially unspooled and positioned over the core.	
<p>3. Release the Print Mechanism by pushing in on the Head Latches. The Print Mechanism will now rotate up.</p>		 A top-down view of the printer with a person's hands pushing in on the green head latches on both sides. The print mechanism is shown rotating upwards.	
<p>4. Feed the label stock through the Label Guides to the Tear-Off Bar.</p> <p>5. Align the Label Guides to the label edge.</p>		 A top-down view of the printer with the label stock being fed through the green label guides. The paper is being aligned with the guides.	
<p>6. Close the Print Mechanism by firmly pressing down on it. You will hear a click when the Print Mechanism has been secured.</p>		 A top-down view of the printer with the print mechanism closed. A label is visible at the bottom of the printer, ready for printing.	

Label Roll Core Installation Instructions

1" Roll Core Installation

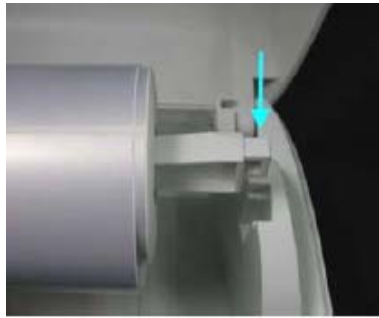

1.5" Roll Core Installation

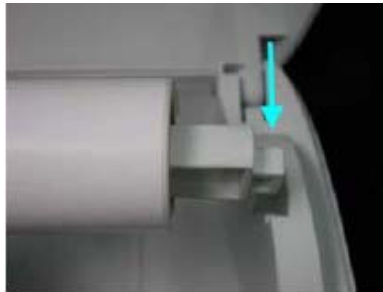

3" Roll Core Installation

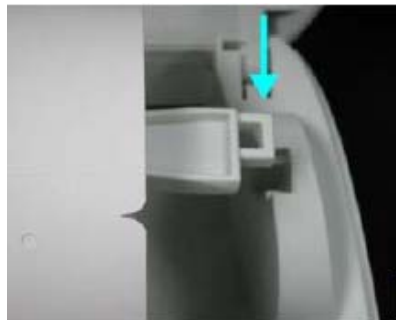
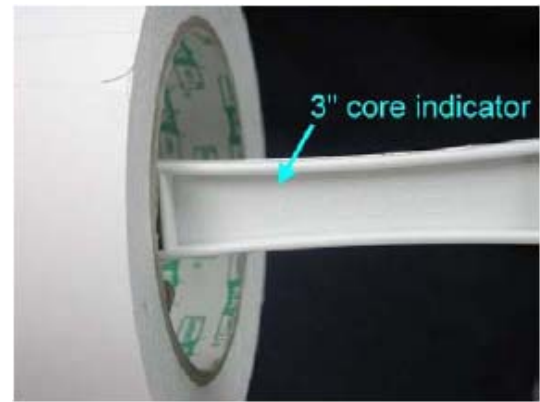

Direct Thermal / Thermal Transfer Mode Switch

To switch into Direct Thermal (DT) Mode:

1. Turn the Printer Off and press and hold the Feed key.
2. Turn the Printer On while holding down the Feed key.
3. The Printer will beep three times. Continue to hold the Feed key down until the Printer beeps three more times. Release the Feed Key after the third beep.
4. The printer will print, "NOW IS DIRECT THERMAL (DT MODE)". This indicates that printer is now in DT Mode.

To switch into Thermal Transfer (TT) Mode:

1. Turn the Printer Off and press and hold the Feed key.
2. Turn the Printer On while holding down the Feed key.
3. The Printer will beep three times. Continue to hold the Feed key down until the Printer beeps four more times. Release the Feed Key after the fourth beep.
4. The printer will print, "NOW IS THERMAL TRANSFER (TT MODE)". This indicates that printer is now in TT Mode.

Card / Hang tag installation

When installing card tags, the tag hole must align with the sensor arrow (as indicated in Photo), and then use the Label Guide to secure the tags.

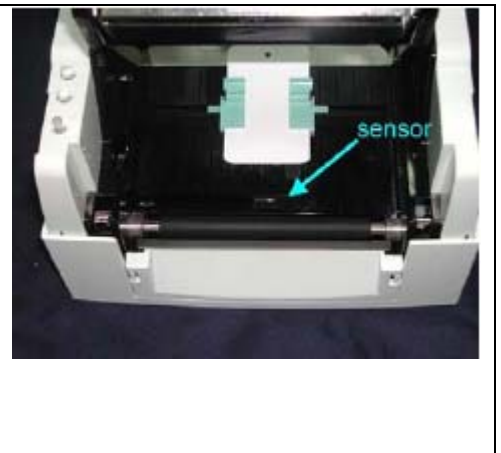
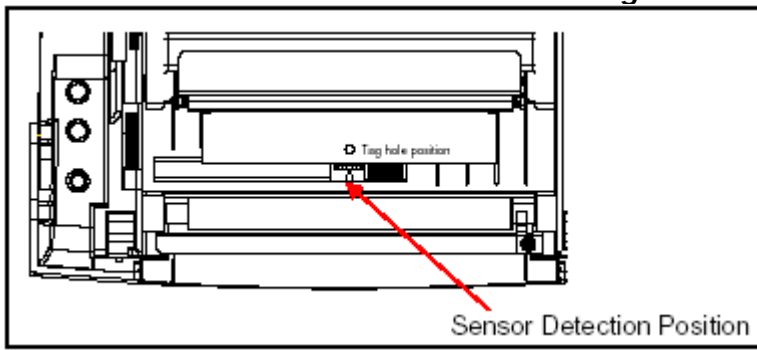

8. Installing the Printer's Optional Accessories

The Optional Stripper Sensor Module, Cutter Module, or 2MB Flash Memory Expansion with Real-Time Clock can be easily installed and configured in the field. This section will provide a component list and installation instructions for these optional accessories.



CAUTION!

Make sure that the Printer's power switch is in the "O" or "Off" position before proceeding with the installation.



CAUTION!

Unplug the power cord from the Printer before performing any service on it. Failure to do so could result in personal injury or damage to the Printer!

THARO V-Series Stripper Sensor Module Components

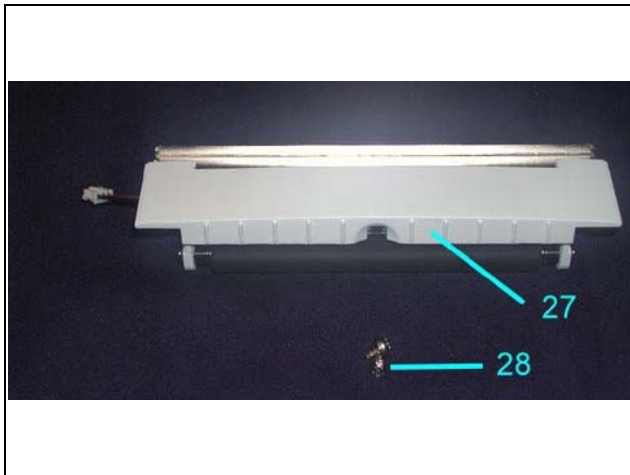

27. Stripper Sensor Module

28. Screws (M3X6), Qty. 2

THARO V-Series Stripper Sensor Module Installation Instructions

1. Open the Printer's Top Cover.

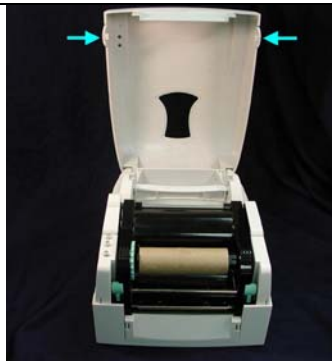

2. The Front Cover Panel has two tabs, one on each side. Push these in to release them and then remove the Front Cover Panel as shown.

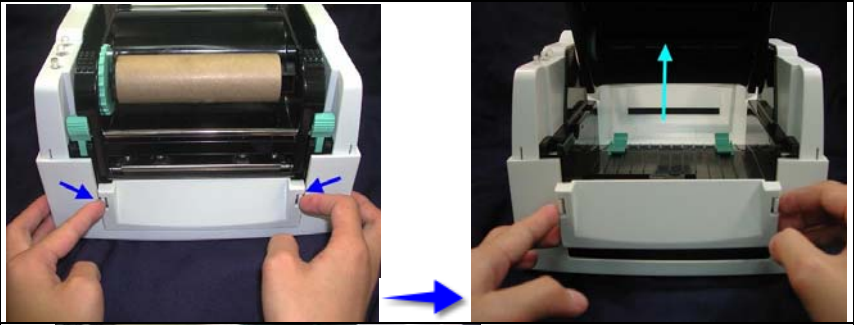

3. To the right you will see two sockets. Choose the socket that has the same number of pins as the connector on the Stripper Sensor Module. Plug the connector into that socket.



4. Position the Stripper Sensor Module as shown.

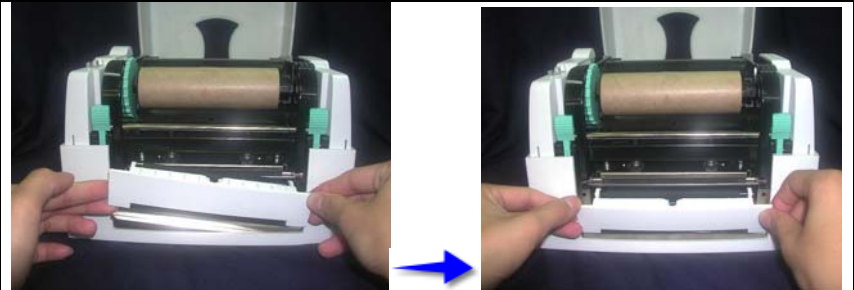

5. Hold the Stripper Sensor Module while tightening the screws.

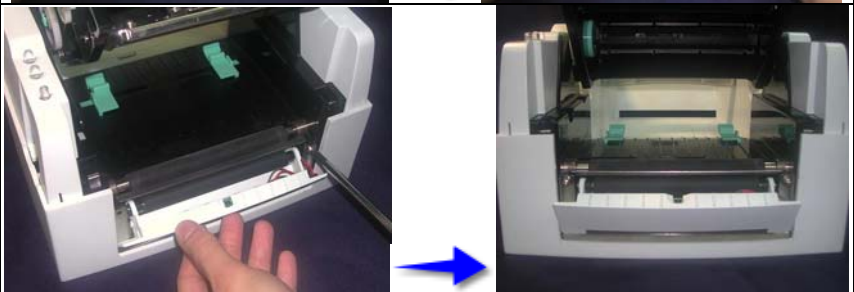

6. Peel off the first label and feed the liner through the roller and peel off bracket.

7. Close the Stripper Sensor Module by pushing it forward as shown.

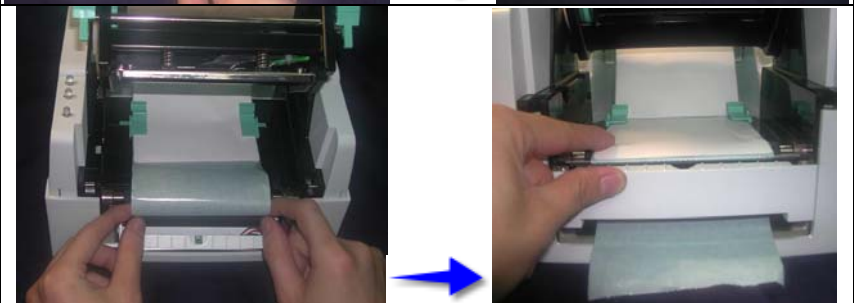

8. Close the Print Mechanism by firmly pressing down on it. You will hear a click when the Print Mechanism has been secured. Then press the FEED Key.



Stripper Sensor Module Installation Diagram

Stripper Sensor Module Installation Diagram

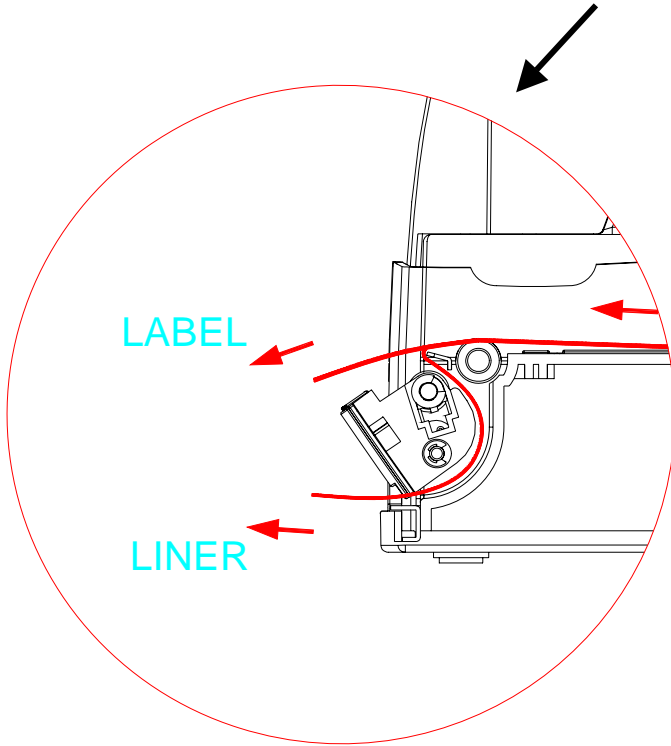
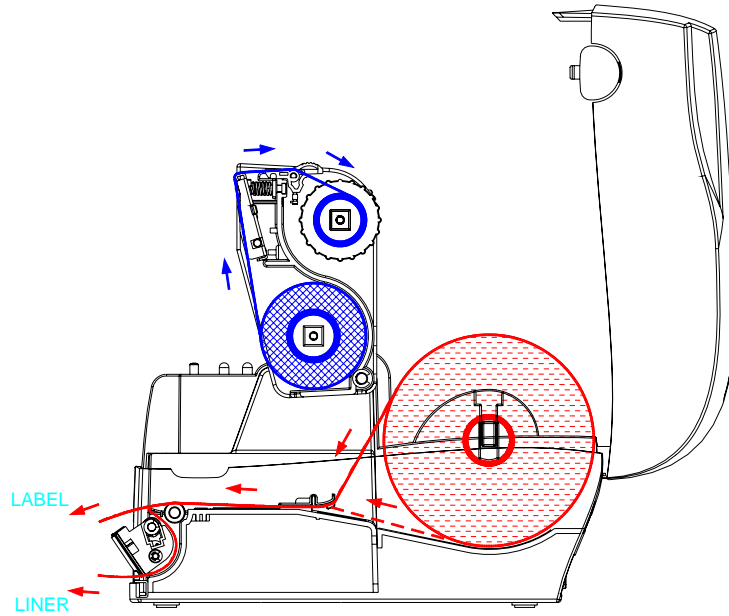

THARO V-Series Cutter Module Components

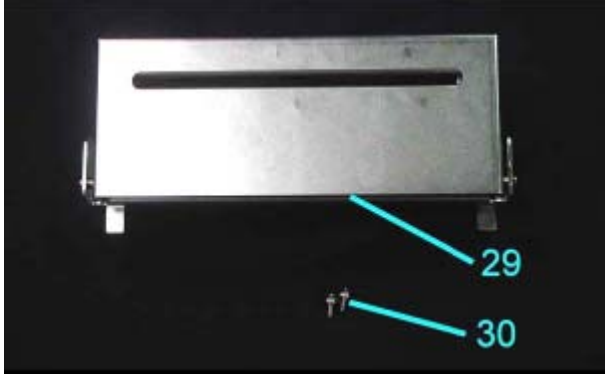
	<p>29. Cutter Module and connector</p> <p>30. Screws (M3X6), Qty. 2</p>
---	---

THARO V-Series Cutter Module Installation Instructions

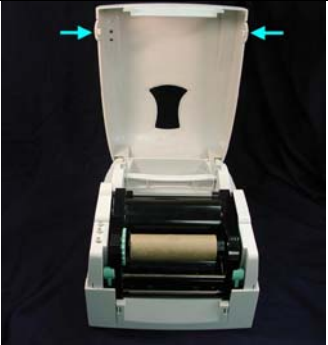
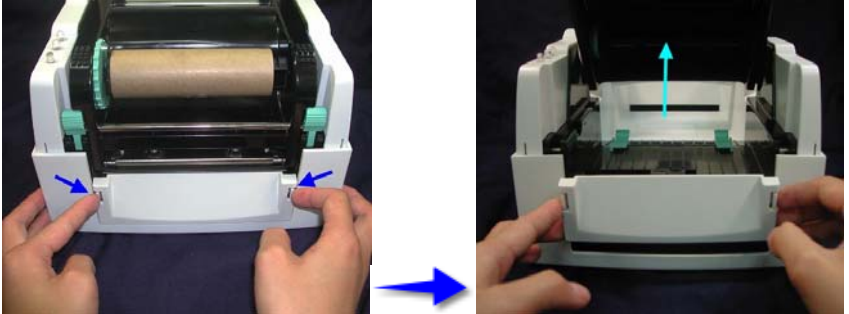
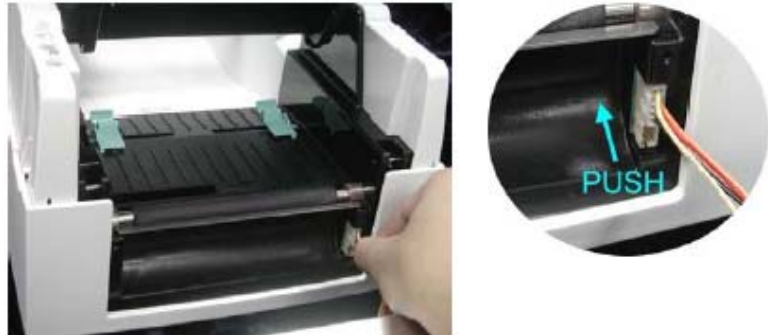
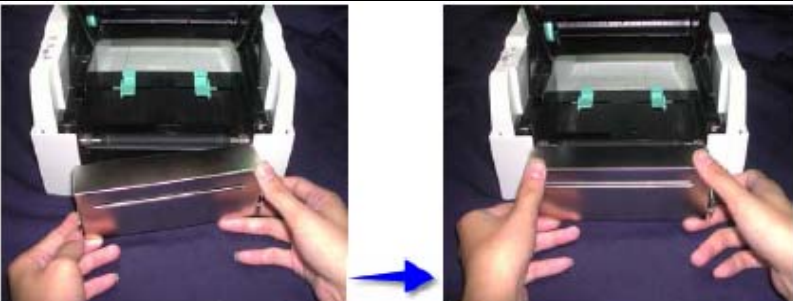
<p>1. Open the Printer's Top Cover.</p>	
<p>2. The Front Cover Panel has two tabs, one on each side. Push these in to release them and then remove the Front Cover Panel as shown.</p>	
<p>3. To the right you will see two sockets. Choose the socket that has the same number of pins as the connector on the Cutter Module. Plug the connector into that socket.</p>	
<p>4. Position the Cutter as shown.</p>	

5. Pull up on the Cutter's Stainless Cover (see photo A) to release the Cutter and then flip the Cutter Module open.

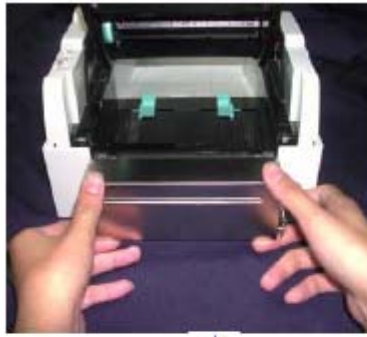

(A)



6. Hold the Cutter Module while tightening the screws.

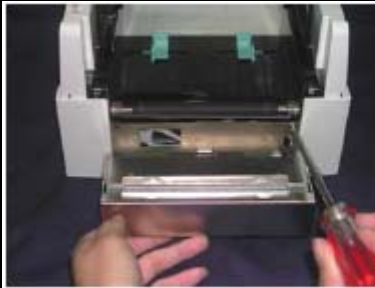

7. Pull on the Cutter's Stainless Cover to release the Cutter and then rotate the Cutter back into place.



8. Close the Print Mechanism by firmly pressing down on it. You will hear a click when the Print Mechanism has been secured.



THARO V-Series 2MB Flash Memory Expansion with Real-Time Clock Components

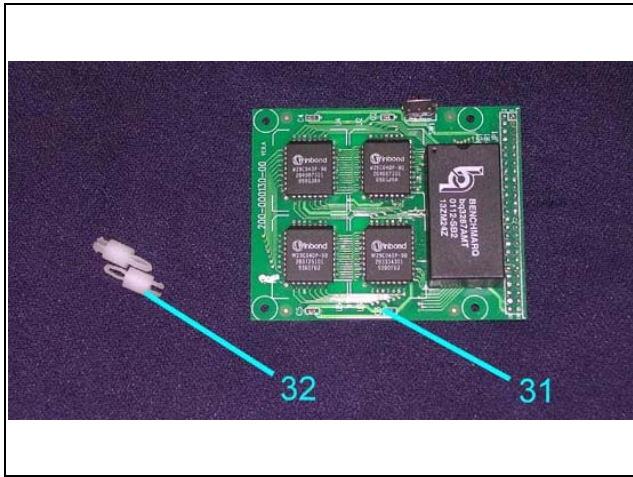

31. 2 MB Flash Memory Expansion Card with Real-Time Clock

32. PCB Pillar, Qty. 2

THARO V-Series 2MB Flash Memory Expansion with Real-Time Clock Installation Instructions

<p>1. Open the Printer's Top Cover.</p>	
<p>2. Remove the Label Roll Core and then open and remove the Memory Expansion Cover.</p>	

3. Insert the PCB Pillars into the holes in the Mainboard.



4. Carefully line up the connector and then plug the Memory Expansion Card into the Mainboard.

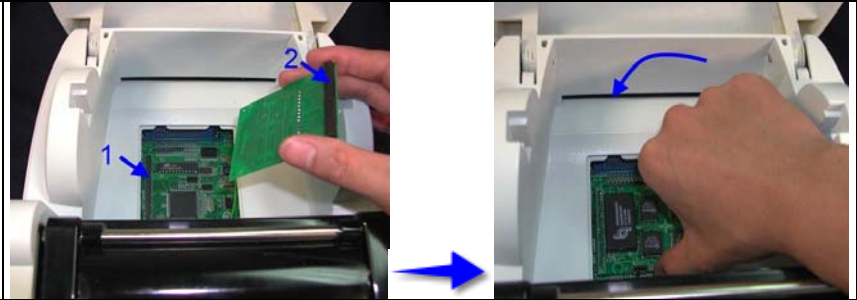

5. Replace the Memory Expansion Cover.

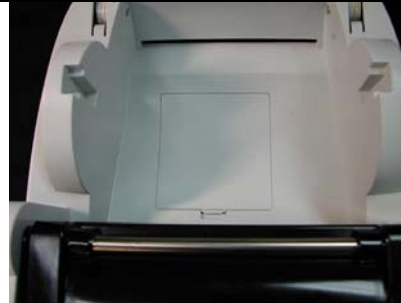

Appendix A. Communication Interfaces

Parallel Interface

The Printers are equipped with a 36-pin Parallel interface connector. Any standard IBM PC compatible parallel cable can be used to connect to your Printer. In the event of any difficulties, the table listed below can be used to obtain a suitable cable.

PIN NO.	FUNCTION	TRANSMITTER
1	Strobe	Host
2-9	Data 0-7	Host
10	Acknowledge	Printer
11	Busy	Printer
12	Paper Empty	Printer
13	Select	Printer
14-15	N/C	
16	Signal Ground	
17	Chassis Ground	
18	+5V DC	
19-30	Signal Ground	
31	Init	
32	Fault	
33	Signal Ground	
34-36	Select	

Serial Interface

The Printers are equipped with a 9-pin SUB-D connector to be used as a Serial interface.

Connector Type: DB9 female, pin assignment is as follows:

PIN NO.	1	2	3	4	5	6	7	8	9
FUNCTION	+5 V	TXD	RXD	N/C	GND	RDY	N/C	RDY	N/C

Serial interface from PC to Printer

PC			Printer
---	1		+5V
RXD	2		TXD
TXD	3		RXD
DTR	4		N/C
GND	5		GND
DSR	6		RDY
RTS	7		N/C
CTS	8		RDY
---	9		N/C

USB Interface

The Printer is equipped with a Type B USB connector that can be connected to any compatible USB port.

PIN NO.	1	2	3	4
FUNCTION	USBVC C	D-	D+	GND

Installation of the USB HS Serial Converter

1. USB is a Plug & Play facility. Once the USB cable is connected from the PC to the Printer, the PC will automatically detect the new device and begin the installation process. You will see a "Building Driver Information Database" Window followed by the Found New Hardware Window.

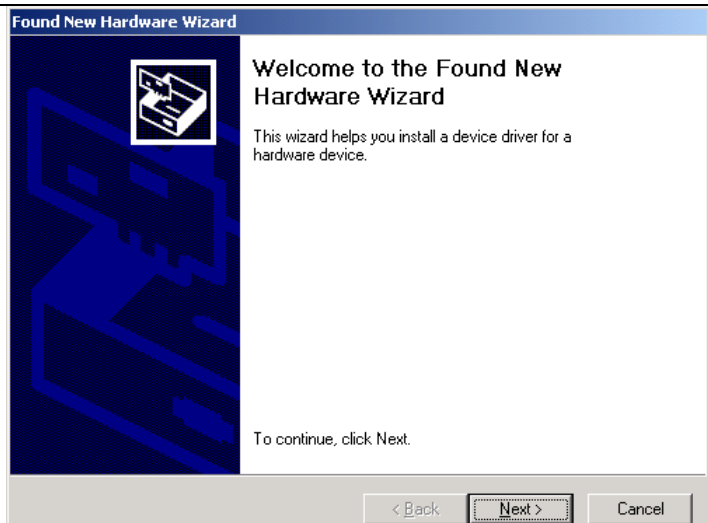

2. Be sure the installation CD that you received with your Printer is in the CD drive on your PC. Select "Search for a suitable driver for my device [recommended]" and click "Next".



3. Select "CD-ROM drives" as the location of the driver.

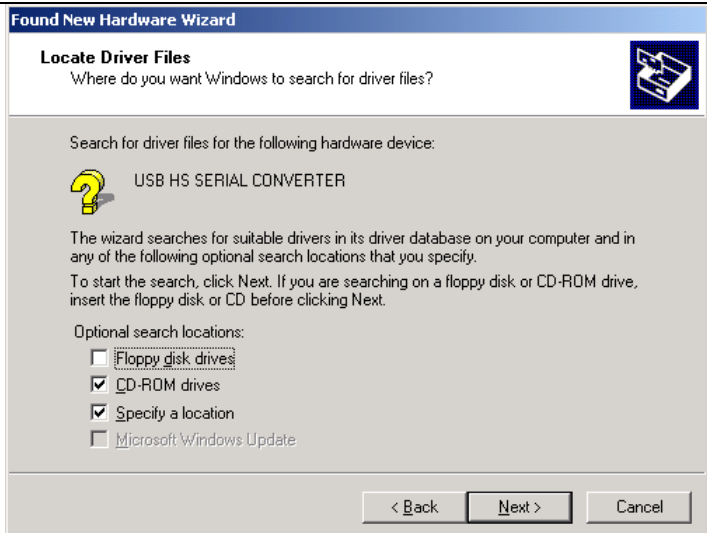

4. Once the USB device driver is assigned and saved, click "Next".



5. This USB device driver uses a virtual COM port that redirects any data sent to it out of the PC's USB port. It will be listed in Device manager as an additional COM Port.

6. Go to Control Panel\System\Device Manager and the USB device's port will be listed under Ports (COM & LPT). The example shown on the right indicates that the USB Serial Port is COM3.

7. After the USB device driver is installed, the USB device can be used through any software (such as EASYLABEL or Windows drivers) to print labels. In this example we would send any print job for this Printer to COM3.

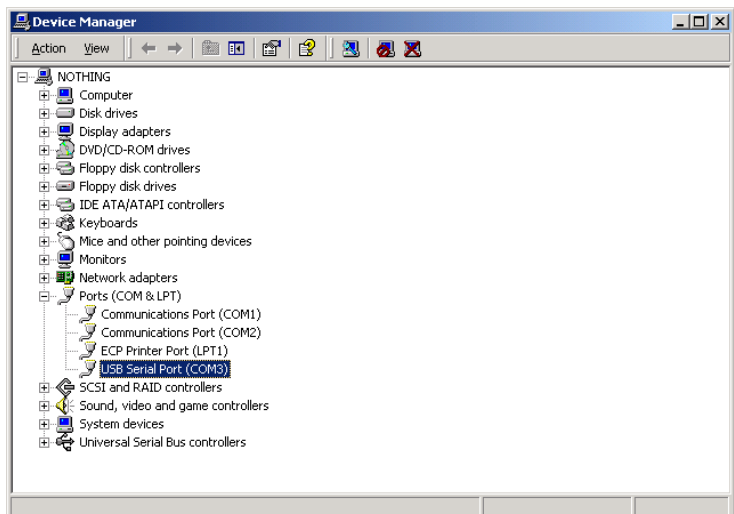

Removing the USB HS Serial Converter

To remove the USB device driver, go to the Windows Control Panel and double click the Add/Remove Programs icon. Click on FTDI USB to Serial Converter Drivers in the program list and click the Add/Remove button. The message box on the right will appear. Click "Continue" to remove the USB device driver.

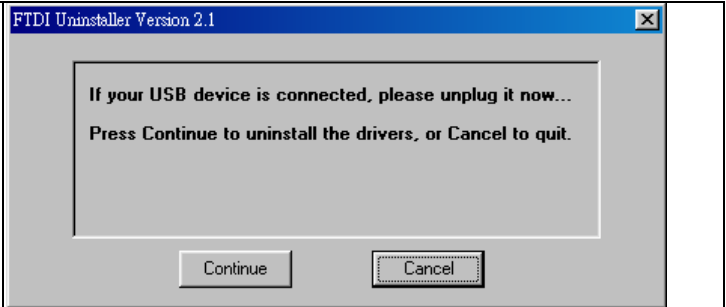

Appendix B. Error Messages / Troubleshooting

Self Test

The Printer's Self Test function prints a Test Label that consists of a test pattern and a variety of information about how the Printer is configured as well as its status.

To perform a Self Test:

1. Turn the Printer Off.
2. Press and hold the Feed key.
3. Turn the Printer On while still holding the Feed key down.
4. Release the Feed key after hearing 3 beeps.

After about 1 second the Printer will print the Test Label. This means the Printer is operating normally.

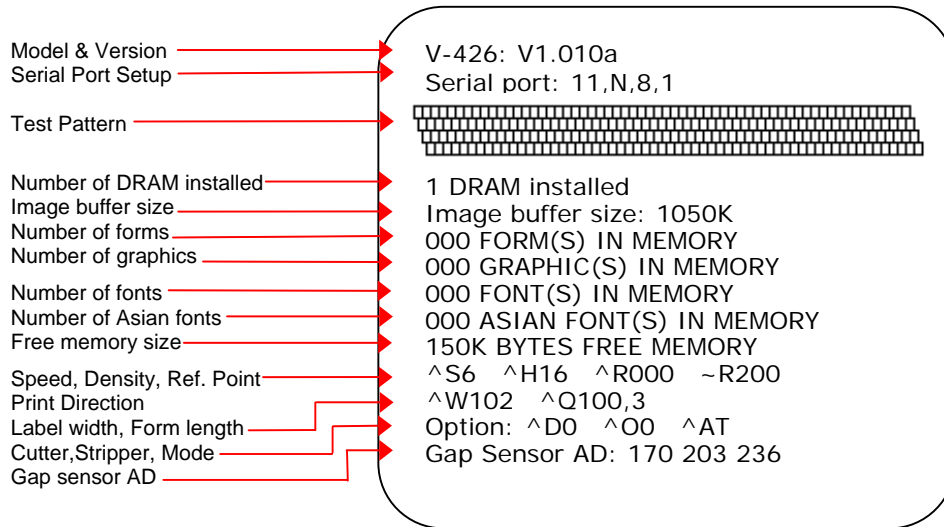

Dump Mode

The Printer's Dump Mode provides the ability to print the command sequences received by the Printer instead of executing them. Dump Mode is very useful as a troubleshooting tool when the label settings and the print results do not match, and can be used to check for errors in data transmission between the Printer and the PC. Examining the Dump Mode print out will confirm whether or not the correct commands were received.

To enter Dump Mode:

1. Turn the Printer Off.
2. Press and hold the Feed key.
3. Turn the Printer On while still holding the Feed key down.
4. The Printer will beep three times. Continue to hold the Feed key down; the Printer will beep again. Continue to hold the Feed key down; the Printer will beep one more time.
5. Release the Feed Key after the last beep. The Printer will print "DUMP MODE BEGIN". The Ready LED will glow Green and the Status LED will glow Orange to show that the Printer is in Dump Mode.
6. Send commands to the Printer and check to see if the commands printed are the same commands sent by your application.
7. Press the Feed key to exit Dump Mode. The Printer will print "OUT OF DUMP MODE" and beep to confirm that it is no longer in Dump Mode.

LED Error Message Descriptions

Condition or Message	LEDs		Beeps	Description	Solution
	Ready	Status			
Print head is open		Red	4	Printhead not firmly in place.	Re-open print head and make sure it closes tightly.
Entering the Cooling Process		Red	None	Printhead temperature is too high.	Printer will go back into Standby Mode after cooling.
Out of ribbon or check Ribbon Sensor		Red	3	No Ribbon is installed, and printer shows error message.	Make sure the printer is in Direct Thermal mode.
				The ribbon is used up or Ribbon Supply Shaft is not moving.	Replace with new ribbon roll.
Out of media or check media gap sensor		Red	2	The Printer is unable to detect label stock.	Make sure the movable sensor is at the correct position. If the sensor is still unable to detect labels then go through the Auto Sensing steps again.
				The label stock is used up.	Replace with new label roll.
Check paper setting		Red	2	Improper paper feed.	Possible causes: 1. Media falling into the gap behind the platen roller. 2. Can't find the label gap/black mark. 3. Black mark paper out.
Command is not recognized		Red	2	Wrong command; the Printer prints out "Command is not recognized".	Check printer commands, possible errors or missing parameters.
Memory is full		Red	2	Memory is full; the Printer prints out "Memory full".	Delete unnecessary data in the memory or add the optional memory expansion module.
Filename can not be found		Red	2	Can't find the file; the Printer prints out "Filename can not be found".	Use "~X4" command to print out all the files and check whether the file exists and the name is correct.
Filename is repeated		Red	2	File name is repeated; the Printer prints out "Filename is repeated".	Change the file name and download again.



NOTICE!

The Printer repeats all warning beeps. For example when the Printer's Printhead Mechanism is opened, the Printer will beep four times, pause, and then beep four more times.

Problems and Recommended Solutions

Problem	Recommended Solution
LED does not light after switching the Printer on	<ul style="list-style-type: none"> ◆ Check the power cord
LED turns red (power/status) after printing stops	<ul style="list-style-type: none"> ◆ Check for software setting or program command errors ◆ Check if labels or ribbon is out and replace with suitable labels or ribbon ◆ Check if label stock is jammed ◆ Check if Printhead Mechanism is closed (Printhead not positioned correctly) ◆ Check if sensor is blocked by paper/label ◆ If cutter is installed check that it is working and working properly
Printing started but nothing was printed on the label	<ul style="list-style-type: none"> ◆ Check that the ribbon is installed with the inked side facing the label media. ◆ Select the correct Printer driver ◆ Select the correct label stock and print mode
The labels jammed when printing	<ul style="list-style-type: none"> ◆ Clear the label jam and check that the Printhead is clean
Only part of the label was printed	<ul style="list-style-type: none"> ◆ Check if label or ribbon is stuck on the Printhead ◆ Check if application software has errors ◆ Check if start position setting has errors ◆ Check if ribbon has wrinkles ◆ Check if Ribbon Supply Shaft is creating friction with the platen roller. If the platen roller needs to be replaced, please contact your Reseller for more information. ◆ Check if power supply is within the voltage range
Part of the label was not printed completely	<ul style="list-style-type: none"> ◆ Check if Printhead is dirty ◆ Use internal command "~T" to perform a Test Print and check if the Printhead can print across its entire width ◆ Check the media quality
Printout not in desired position	<ul style="list-style-type: none"> ◆ Check if sensor is covered by paper or is dirty ◆ Check if liner is suitable for use, please contact Reseller for more information ◆ Check if label roll edge is aligned with Label Width Guide
Labels are skipped while printing	<ul style="list-style-type: none"> ◆ Check if error occurs on label height setting ◆ Check if the sensor is covered by paper or is dirty
Smudged or blurry printout	<ul style="list-style-type: none"> ◆ Check print darkness setting ◆ Check if Printhead is dirty
The Cutter did not cut straight	<ul style="list-style-type: none"> ◆ Check if label stock is installed correctly
The Cutter did not cut the label successfully	<ul style="list-style-type: none"> ◆ Check if the label thickness exceeds 0.16mm (.006")
When using the Cutter the labels could not feed or abnormal cutting occurs	<ul style="list-style-type: none"> ◆ Check if Cutter is installed properly ◆ Check if Paper Feed Rods are sticky ◆ Check that label is greater than 35mm (1.38") high so it can clear the Cutter
The Stripper Sensor is not functioning correctly	<ul style="list-style-type: none"> ◆ Check if Stripper Sensor is covered with dust ◆ Check if labels are installed properly

Appendix C. Maintenance and Adjustment

Cleaning the Thermal Printhead



CAUTION!

The Printhead is the Most Fragile part of your Printer. Do NOT use sharp or hard objects to clean the Printhead. Do NOT touch the glass surface of the Printhead with your hand.



CAUTION!

During the print process the Printhead will become hot. Do NOT attempt to clean the Printhead until it has had time to cool.

Printing labels will cause dirt such as paper dust, particles of ink and label adhesive to accumulate on the Thermal Printhead. This can cause poor print quality and incomplete printouts. When this happens the Printhead must be cleaned:

1. Turn the Printer Off.
2. Open the top cover.
3. Release the Print Mechanism by pushing in on the Head Latches. The Print Mechanism will now rotate up.
4. Remove the ribbon from the Printer.
5. Clean the Printhead surface (see blue arrow) with a special cleaning pen or a cotton swab soaked in Isopropyl Alcohol.
6. Allow the Printhead to dry for 2-3 minutes before turning the Printer back on.

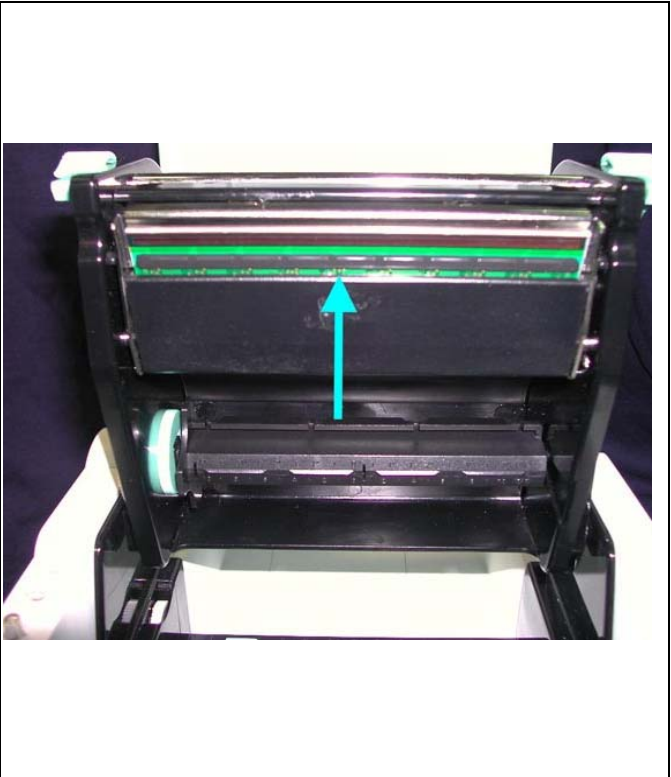

NOTICE!

To help keep the Printhead clean the top cover of the Printer should be closed when printing. To ensure print quality and prolong Printhead life, do NOT use dusty or dirty print media in the Printer.



NOTICE!

Recommended cleaning intervals for the Thermal Printhead:
Direct Thermal Printing – Each time the label roll is changed
Thermal Transfer Printing – Each time the ribbon is changed

Thermal Printhead Print Line Adjustment

When printing on stiff or thick paper, the Print Line needs to be moved forward (paper feed direction) in order to achieve better print quality.

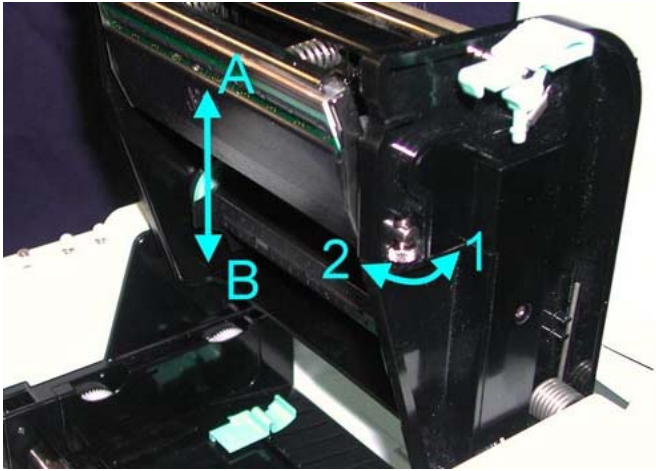
<ol style="list-style-type: none">1. Release the Print Mechanism by pushing in on the Head Latches. The Print Mechanism will now rotate up.	
<ol style="list-style-type: none">2. Turning the Print Line Adjustment counterclockwise (as arrow 1 shows) will move the Printhead in the direction of arrow A.3. Turning the Print Line Adjustment clockwise (as arrow 2 shows) will move the Printhead in the direction of arrow B.	

Thermal Printhead Spring Box Pressure Adjustment

If one side of the printed labels is not being printed clearly, or if ribbon wrinkles occur, then adjust the Thermal Printhead Spring Box Pressure to cure the problem.

<ol style="list-style-type: none">1. Open the Top Cover.2. Remove the Thermal Transfer Ribbon.3. Turn the Printhead Adjustment Screws to increase or decrease the Printhead pressure.	
---	--

Thermal Printhead Replacement

1. Switch the power to the printer off and unplug the printer.
2. Open the Printhead and remove the media from the printer.
3. Remove the Printhead Carriage Screw as shown.

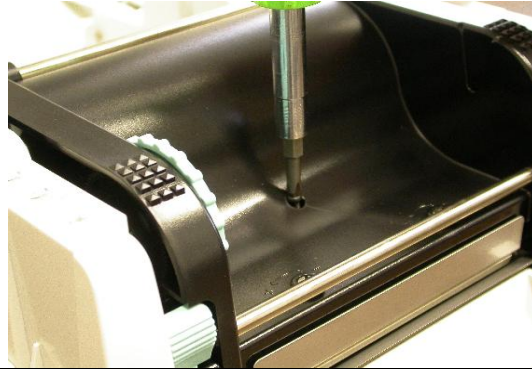

4. Once the Printhead Carriage Screw is removed, the Printhead Carriage will drop down and provide access to the Printhead Screws.

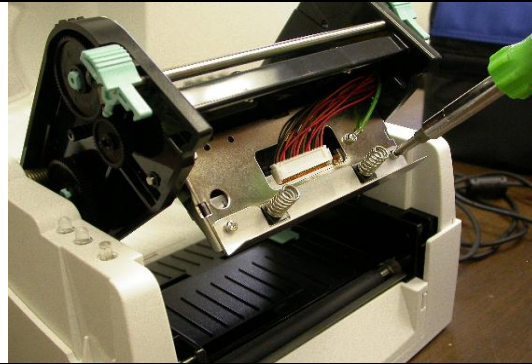

5. Remove the two Printhead Screws

6. Remove the plastic Printhead Guard from beneath the Printhead and the Printhead will hang from the Carriage by the Printhead Cable



7. Gently unplug the Printhead Cable from the Printhead.
8. Reverse these steps to re-install the Printhead.

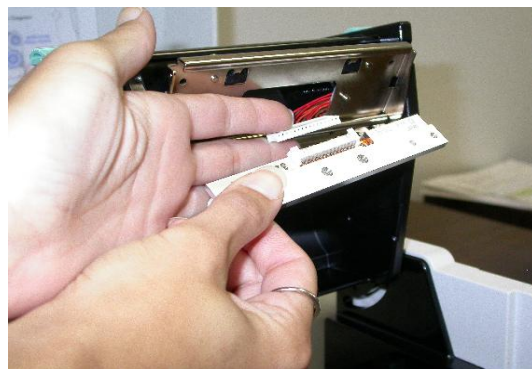

Auto Sensing

Using Auto Sensing the Printer automatically detects and records the label type and length (gap or black mark paper). Then the Printer can accurately detect the label positions.

1. Adjust the Moveable Sensor so that it is located in a position to sense the label gaps or black marks.
2. Turn the Printer Off and press and hold the Feed key.
3. Turn the Printer On while holding down the Feed key.
4. The Printer will beep three times. Continue to hold the Feed key down; the Printer will beep again. Then release the Feed key.
5. The Printer will now detect and record the label size/length.

Upgrading the Printer's Firmware

The Printer's firmware can be upgraded in the field by performing the following procedure: Connect the Printer to a computer using a parallel cable. Unzip the firmware files and save them to a directory on your computer. Double-click on the file D.bat. This will open a DOS Window and start the download process. The Printer will beep once and the Status light will flash red rapidly. When the download is complete, the Status light will stop flashing and the Printer will beep twice and reset.

Printer Setup

By holding down the Feed button and turning the power on, you will be able to change the printer settings depending on how many times the printer beeps before the Feed button is released. When the printer is first powered up, the printer will beep 3 times quickly, then will continually beep slowly after that.

Printer Setting	Adjustment/Slow Beeps
Self Test	0 beeps
Auto Sensing	1 beep
Dump Mode On	2 beeps
Direct Thermal	3 beeps
Thermal Transfer	4 beeps
See Through Sensor ON	5 beeps
Top of Form ON/OFF	6 beeps

Clearing Cutter Jams

1. If the Cutter jams or malfunctions turn the Printer Off.
2. There is a hole (marked "A") on each side of the Cutter. Insert a 3mm hex key into one of these holes and turn the cutter blade clockwise.
3. After the problem is corrected, turn the Printer back On and the cutter blade will go back to its original position.

Note: It is recommended to use labels greater than 35mm (1.38") in height in order for them to clear the Cutter.

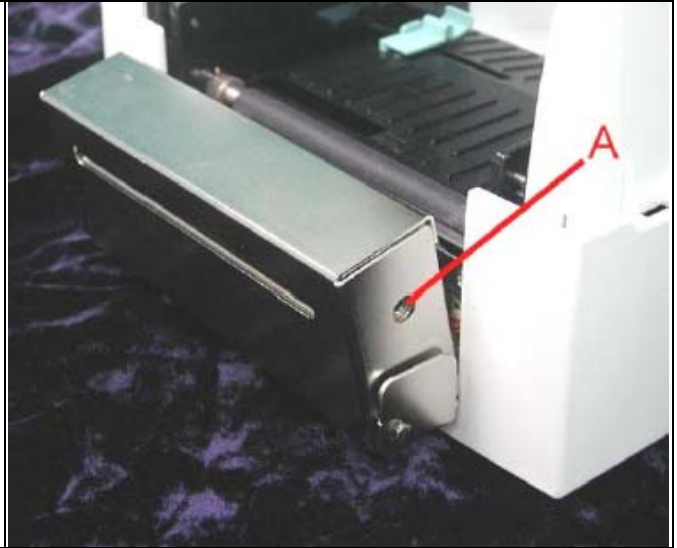

Cleaning Adhesive from the Cutter Blade

When using adhesive labels, the cutter may malfunction due to a build up of adhesive on the blade. When this happens it will be necessary to clean the Cutter Blade:

1. Turn the Printer Off.
2. Remove the Cutter assembly from the printer.
3. Wet a cotton swab in Isopropyl Alcohol and use it to remove any build-ups of adhesive.
4. There is a hole (marked "A") on each side of the Cutter. Insert a 3mm hex key into one of these holes and turn the cutter blade clockwise to allow access to the entire length of the blade.
5. Allow the cutter to dry for 10 minutes.
6. Re-install the Cutter assembly and turn the Printer back On. The cutter blade will go back to its original position.

